

| | | | |
|---|-------|-----------|---|
| 1 | 1 | IPC/RSLA3 | COMPACT A3 - RSL |
| Pos. | Menge | Einheit | Sachnummer |
| | | | Benennung / Merkmale |
| | | | Werkstoff |
| | | | Systemic Datentechnik AG Tafelstrasse 28 5405 Baden-Dätwil Switzerland Telefon +41 56 200 90 40 Fax +41 56 200 90 50 |
| HINWEIS: Diese Zeichnung ist unser Eigentum und darf ohne unsere Genehmigung weder vervielfältigt, noch dritten Personen zugänglich gemacht werden. | | | Artikel-Nr. |
| Mechanical Drawing IPC/RSLA3 | | | |
| Zeichnungs-Nr. (Bauteilnummer) | | | Blatt-Nr. |
| Masstab 1:2 | | | 1 Format A2 |
| EDV-Nr.: I:\Konstruktion\DATEN\Projektel_IPC\CompactA3\RSLA3.lam | | | |

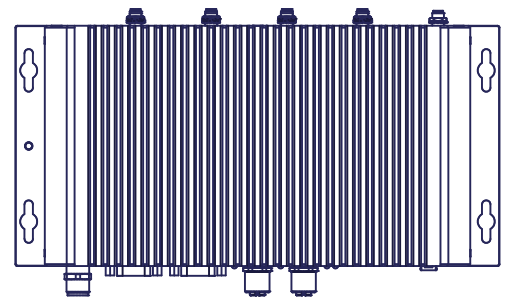
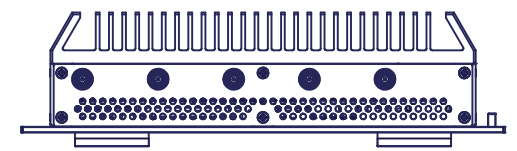
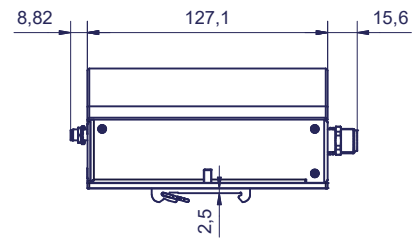
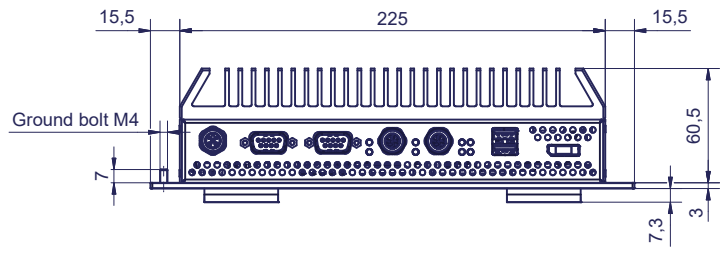
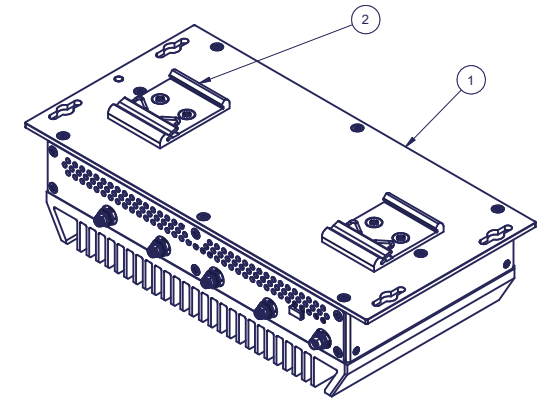
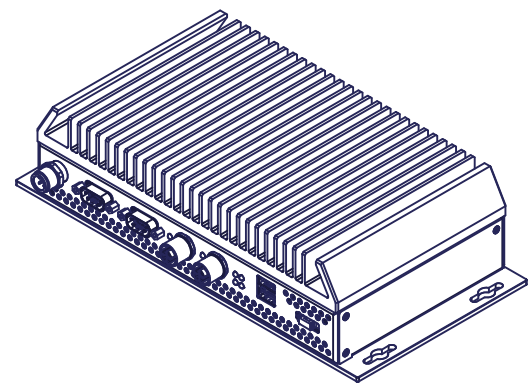
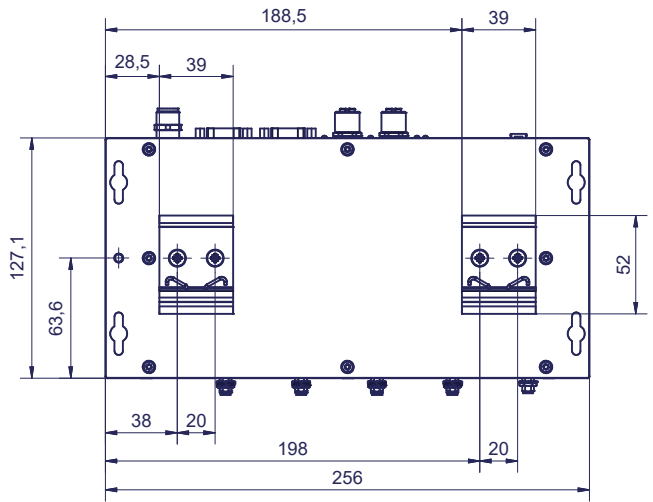

| 2 | 1 | | IPC/MKITCP-2G41 | COMPACT - DIN Rail Clip | |
|------|-------|---------|---|-------------------------|-----------|
| 1 | 1 | | IPC/RSLA3 | COMPACT A3 - RSL | |
| Pos. | Menge | Einheit | Sachnummer | Benennung / Merkmale | Werkstoff |
| | | | syslogic | | |
| | | | Systemic Datentechnik AG Tafelstrasse 28 5405 Baden-Dätwil Switzerland Telefon +41 56 200 90 40 Fax +41 56 200 90 50 | | |
| | | | HINWEIS: Diese Zeichnung ist unser Eigentum und darf ohne unsere Genehmigung weder vervielfältigt, noch dritten Personen zugänglich gemacht werden. | | |
| | | | Artikel-Nr. | | |
| | | | Mechanical Drawing IPC/RSLA3 | | |
| | | | Zeichnungs-Nr. (Bauteilnummer) | | |
| | | | Blatt-Nr. | | |
| | | | Format | | |
| | | | COMPACT A3 - RSL | | |
| | | | Masstab 1:2 | | |
| | | | EDV-Nr.: I:\Konstruktion\DATEN\Projektel_IPC\CompactA3\RSLA3.lam | | |